

WALL WASH

5821

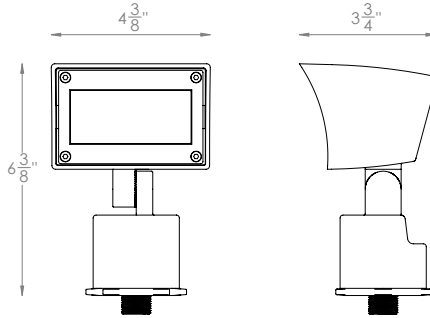

Fixture Type:

Catalog Number:

Project: _____

Location: _____

PRODUCT DESCRIPTION

Dynamic, eye-catching stunning vignettes. Celebrate artful illumination with new COLORSCAPING Wall Wash and Accent Lights from WAC Landscape Lighting. Heighten drama to render visual impact on magnificent tree trunk and branch silhouettes, brilliant colorful scenery on your hedgerow, or a swath of light washing a facade. Customize your experiences and enjoy your passion for color and the language of light with unbridled enthusiasm and a nearly endless palette. The possibilities are endless.

FEATURES

- Each fixture can be individually controlled
- Fixtures can be grouped and controlled together
- Fixtures contain discrete, warm, and a cool white LEDs for full tunability
- Fixtures can generate tens of thousands of different colors
- Automations can be stored and recalled for holiday or other celebratory lighting scenes
- Fixtures from multiple transformers can be controlled as a single group in the app
- Integrators can control the fixtures using industry standard DMX 512
- The colorscaping transformer allows for installation growth - each transformer supports one or two legacy landscape lighting circuits in addition to the color scaping fixtures
- Mounting stake, 6' lead wire and direct burial gel filled wire nuts included
- Schedule your landscape lighting based on sunrise and sunset in your location
- RGBWW Color Changing Fixture: R / G / B / 2700K-6500K

SPECIFICATIONS

- Input:** 15VAC (Colorscaping Smart Transformer is required)
Power: 16W / 24.5VA (Use VA value for sizing the transformer and calculate voltage drop.)
Brightness: White: 1015
 Red: 360
 Green: 680
 Blue: 140
Beam Angle: 50° by 80°
CRI: 85
Rated Life: 50,000 hours

ORDERING NUMBER

	Color Temp	Finish
5821 Wall wash	CS Color Changing	BK Black on Aluminum BZ Bronze on Aluminum BBR Bronze on Brass

5821-_____

Example: **5821-CSBK**

wacighting.com

Phone (800) 526.2588

Fax (800) 526.2585

Headquarters, East Manufacturing Facility

44 Harbor Park Drive

Port Washington, NY 11050

South East Manufacturing Facility

1600 Distribution Ct

Lithia Springs, GA 30122

Central Manufacturing Facility

1700 South J Elmer Freeway, Ste 100

Cedar Hill, TX 75104

West Manufacturing Facility

1750 S Archibald Ave









Ontario, CA 91761

WALL WASH

5821



Accessories

Additional Stake		9000-ST9-BZ	Bronze	Durable PVC stake
Surface Mount Flange/Stake		5000-SCP-BK 5000-SCP-BZ 5000-SCP-BBR	Black on Aluminum Bronze on Aluminum Bronze on Brass	Includes three 7 inch threaded stainless steel stabilizing pins for ground mounting or surface mounts with four screws or over a junction box
Guardian Mount		9000-SP9-BZ	Stainless Steel	Heavy duty stainless steel spike to position fixture Formed from a single piece of metal
Gutter Mount Bracket		5000-GM-BZ 5000-GM-BK	Stainless Steel	Stainless Steel universal mounting bracket for gutter mounting fixture
Extension Rods		5000-X04-BZ 4 in 5000-X04-BK 4 in 5000-X04-BBR 4 in 5000-X08-BZ 8 in 5000-X08-BK 8 in 5000-X08-BBR 8 in 5000-X12-BZ 12 in 5000-X12-BK 12 in 5000-X12-BBR 12 in	5000-X18-BZ 18 in 5000-X18-BK 18 in 5000-X18-BBR 18 in 5000-X24-BZ 24 in 5000-X24-BK 24 in 5000-X24-BBR 24 in	Extends distance between Accent light and Surface Mount Canopy, Stake, or Tree Mount box
Honeycomb Louver		5021-HCL	Black	To reduce glare
Tree Mount Junction Box		5000-TCP-BK 5000-TCP-BZ	Black on Aluminum Bronze on Aluminum	Bronze on Aluminum box with Stainless steel mounting screws. Two ½" NPT threaded holes.
		5000-TCL-BK 5000-TCL-BZ	Black on Aluminum Bronze on Aluminum	Large aluminum box with stainless steel mounting screws; two 1/2" NPT threaded holes, UL 120V listed
Large Tree Mount Canopy Strap		5000-TST-BK	BK - Black in Stainless Steel	Ratcheting device with strap to be used with Large Tree Mount Junction Box (5000-TCL)
		5000-STB-BK	BK - Black in Stainless Steel	Tree mount bracket only mj

Magnetic Transformers

Stainless Steel, 15V output, IP65 rated, UL 1838 listed
See transformer spec sheet for details and its accessories

8150CS-TRN-SS
150W Max

8300CS-TRN-SS
300W Max



wacighting.com
Phone (800) 526.2588
Fax (800) 526.2585

Headquarters, East Manufacturing Facility
44 Harbor Park Drive
Port Washington, NY 11050

South East Manufacturing Facility
1600 Distribution Ct
Lithia Springs, GA 30122

Central Manufacturing Facility
1700 South J Elmer Freeway, Ste 100
Cedar Hill, TX 75104

West Manufacturing Facility
1750 S Archibald Ave
Ontario, CA 91761